

FXVIM02 Vibration interface module

ControlNet™ FLEX I/O™ Combustion pressure fluctuation, Combustion vibration input, FFT analysis

*ControlNet™ is ControlNet International's registered trademark.
*FLEX I/O™ is Rockwell Automation's registered trademark.

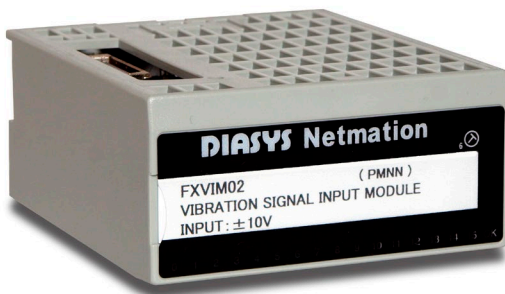

■ Outline

- * Combustion pressure fluctuation input
- * Combustion vibration input
- * FFT analysis

ITEM	SPECIFICATION
Analog inputs	±10 V × 4
Input impedance	More than 10 kΩ
Auxiliary inputs (without isolation)	Digital input × 2 Pulse input × 2
Auxiliary outputs (without isolation)	1 to 5 V AC × 4 Digital output × 7
Filter	Low path filter 1 Cut-off frequency : 15 kHz Low path filter 2 Cut-off frequency : 1.5 kHz
Serial interface (For maintenance)	EIA/RS-232C (PS/2) × 1
Self-diagnostic functions	Application abnormal Watchdog timer Clock monitor Connector omission Power supply voltage low Bus time-out
Indicator	LED × 1 3 Modes Green (Control) Yellow (Standby) Red (Abnormal) LED × 16 Yellow (General purpose)
Compatible terminal bases	1794-TB3/TB3S 1794-TBN/TBNF
Dielectric strength	AC 500 V Between analog I/O terminal and FG (1 min.) AC 1500 V Between digital I/O terminal and FG (1 min.)
Environmental conditions	(Operating) Temperature: 0 to 55°C Humidity: 35 to 95% RH (No condensation) (Storage) Temperature: -10 to 70°C Humidity: Less than 80% RH (No condensation)
Power supply	DC 24 V ±10% / Less than 400 mA DC 5 V / Less than 80 mA (FLEX BUS)
Shock/Vibration	15 G / 2 G @ 10 to 500 Hz
Dimensions	110 mm (D) × 46 mm (H) × 92 mm (W)

This product uses technology licensed from Rockwell Automation Technologies, Inc.

FXVIM02 Vibration interface module

ControlNet™ FLEX I/O™ Combustion pressure fluctuation, Combustion vibration input, FFT analysis

*ControlNet™ is ControlNet International's registered trademark.
*FLEX I/O™ is Rockwell Automation's registered trademark.

FXVIM02 block diagram

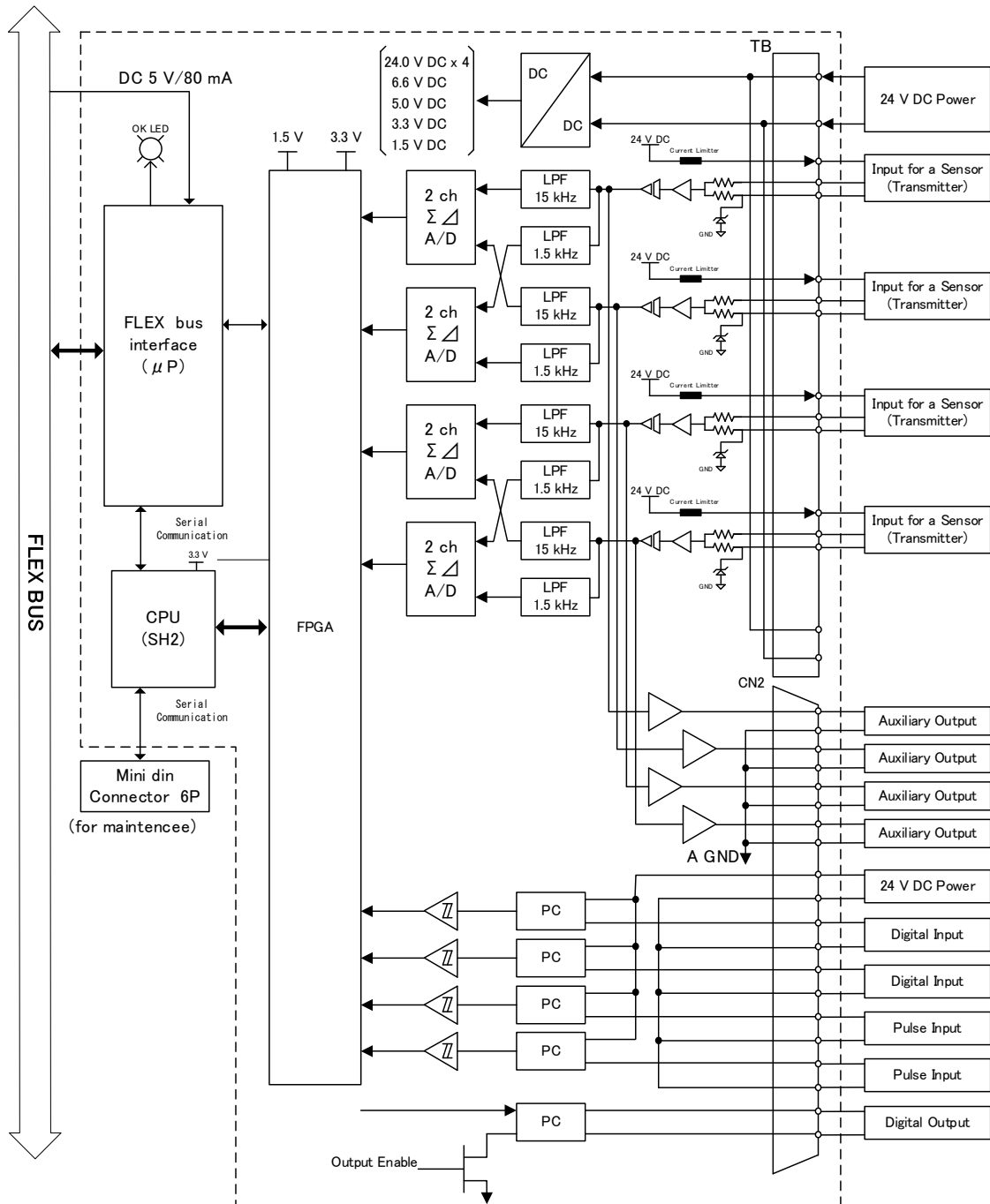

When using, please read the instruction manual attached to the product carefully and use it properly.

This catalog may not be distributed or reproduced in whole or in part without permission.

Please be aware that due to product improvements and modifications, the product description in this catalog may differ in certain respects from the actual product.

DIASYS Netmation/DIASYS Netmation4S is a registered trademark of Mitsubishi Heavy Industries, Ltd.

The service names and product names of other companies described in this catalog are the trademarks or registered trademarks of each company.